

DETAIL OF MOUNTING BLOCK

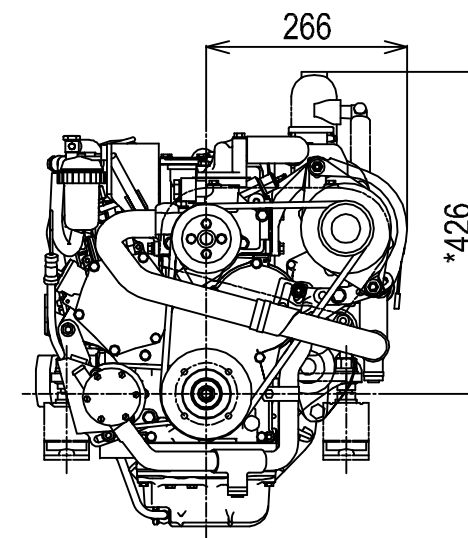

DETAIL OF COUPLING

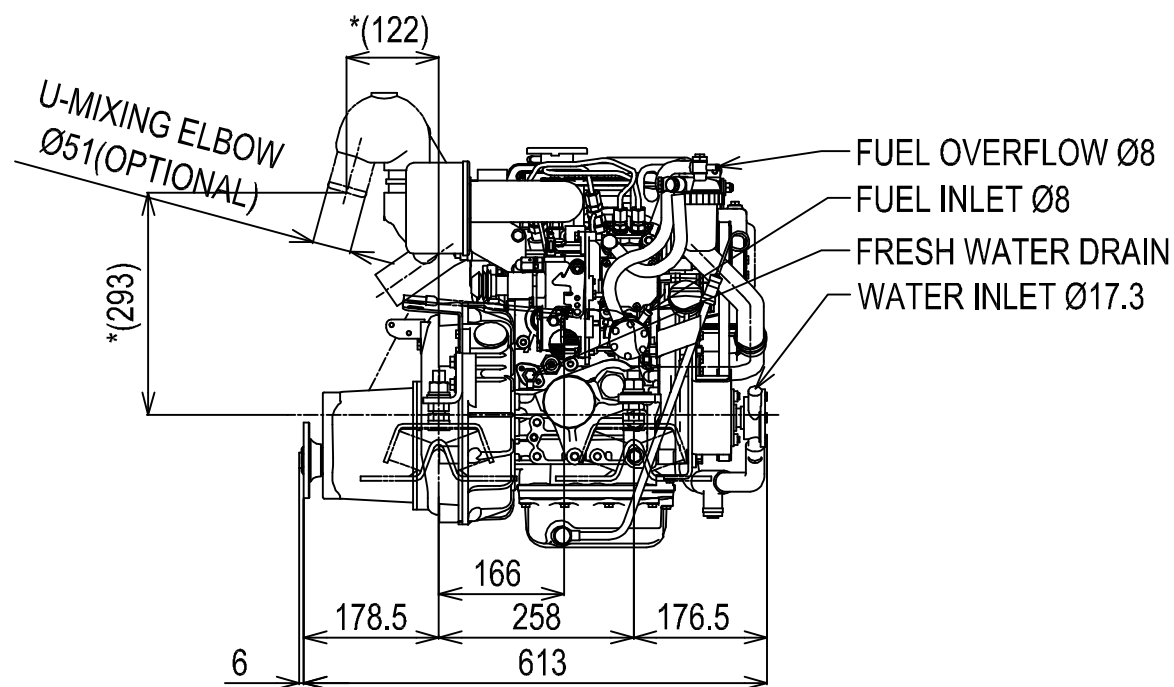
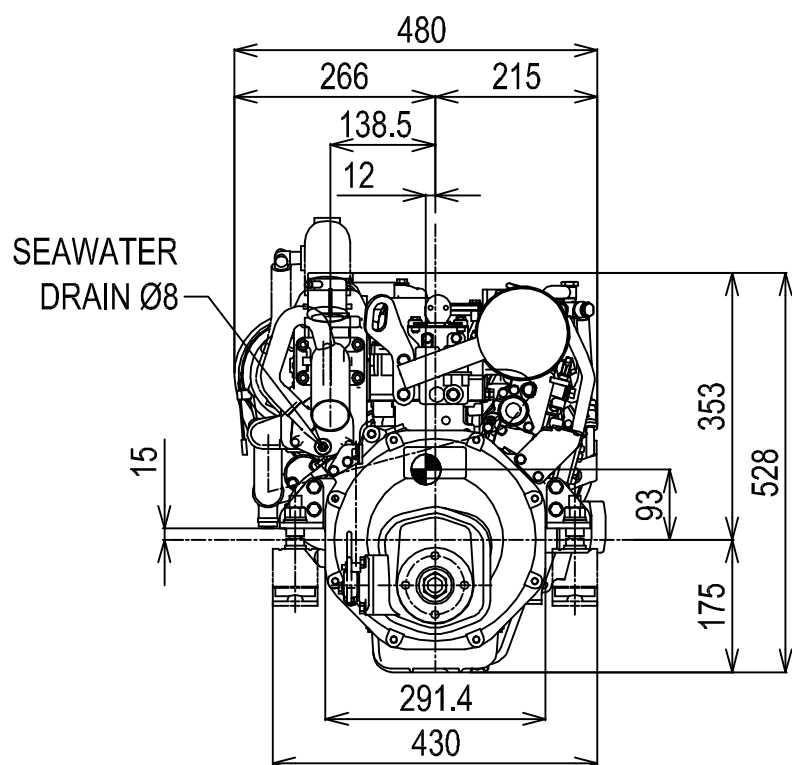
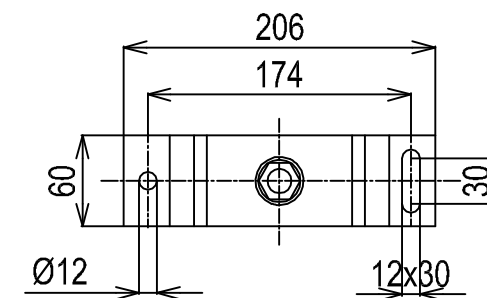
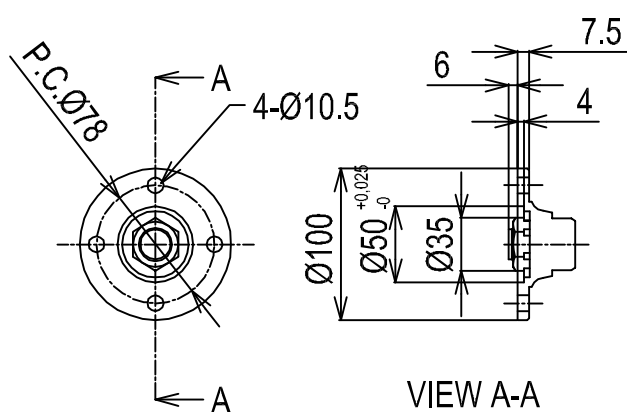

DIRECTION OF ROTATION

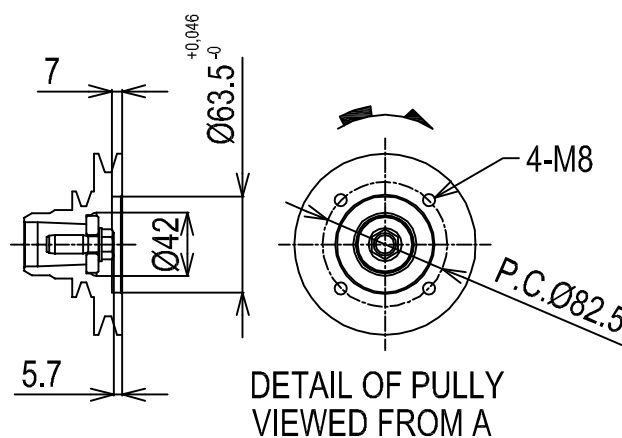

NOTE:

- 1.DWG.SHOWS MOUNTING BLOCKS AT ORIGINAL HEIGHT. ENGINE WEIGHT WILL COMPRESS BLOCKS BY 4.5 MM(APPROX).
- 2.MOUNTING BLOCKS ARE EQUIPPED FOR STANDARD ACCESSORY.
- 3.● SHOWS THE CENTER OF GRAVITY.
- 4.FOR ADDITIONAL INSTALLATION INFORMATION AND SPECIFICATIONS PLEASE REFER TO THE YANMAR ENGINE INSTALLATION MANUAL

Series: YM	Engine: 2YM15xKM2P-1	Release: R2010-01
Scale: 1:10	Date: 01-03-10	Dimensions: mm

